

工控級BLDC調速型無刷伺服馬達

BLDC Brushless Control-speed Servo Motor



L190xW160xH50



40、80、120W



175、350、500W



400、750、1000W

控速範圍：200~3000RPM Speed Control Range:200~3000RPM

BLDC-H-S馬達接線說明

BLDC-H-S Brushless Motor Connection Diagram

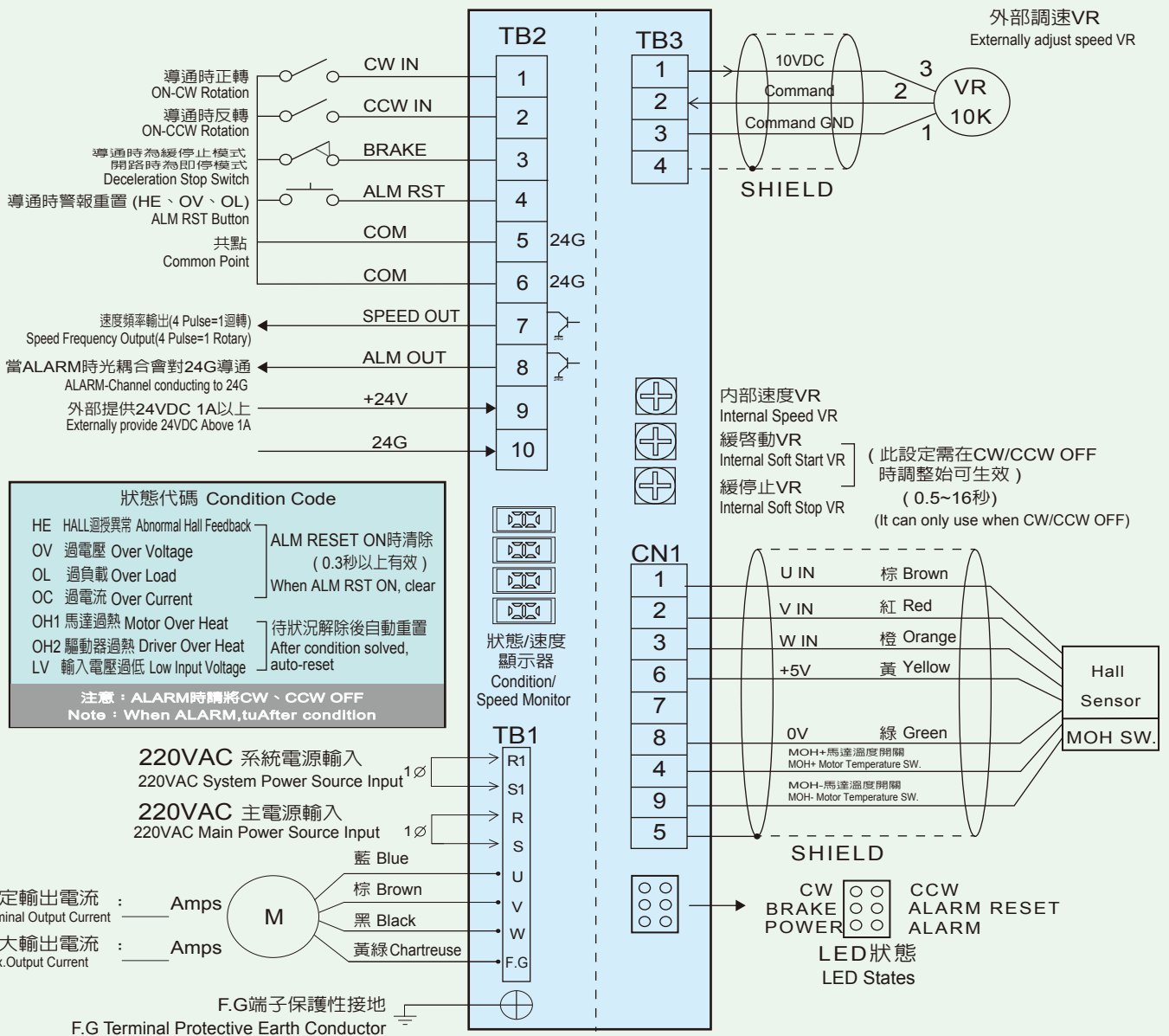

註Note：

1. 信號線長應在15M以內，並避開強電通道。
2. 如馬達無溫度開關時，CN1之4、9PIN短路。
3. 其他規格接受訂製。
1. The signal cable should be within 15M of the length, and avoid high voltage channel
2. ACC/DCC 0.5-16 seconds(32 stages)Max.Speed 3000RPM
3. If no Motor temperature SW.,shorten 4.9.PIN of CN1.
4. The electronic BRAKE of TB2 must set in stop status
5. Accept tailor-made for other specification

危險Caution：



- (1) 主電源於斷電後須等待2分鐘後始能接觸作業。
- (2) 任何電力作業前請確認(保護性接地)務必接受。
- (1) Main power source should wait for 2 minutes to work after power cut.
- (2) Before any electricity work, please confirm that the protective earth conductor has connected.



MAH Series

BLDC Brushless Servomotors

Technical Data

Parameter	Unit	40W	80W	120W	175W	350W	500W	400W	750W	1000W
Motor Rates Speed	RPM	3000	3000	3000	3000	3000	3000	3000	3000	3000
Max.Voltage	V	24	24	24	220	220	220	220	220	220
Cont.Rated Torque TENV	Nm	0.13	0.26	0.39	0.56	1.12	1.65	1.59	2.38	3.18
Cont.Rated Current TENV	Amps	3.0A	5.0A	8.0A	1.9A	3.5A	4.7A	3.7A	6.3A	8.6A
Max.Temperature	°C	85	85	85	85	85	85	85	85	85
Motor Weight	kg	0.7	1	1.27	1.7	2.5	3.4	2.9	4.3	6.1

FEEDBACK

Specification Supply Voltage
5V

HALL SENSOR

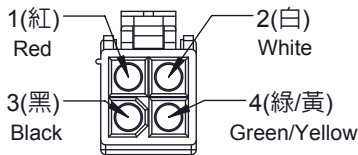
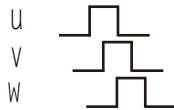

(A-A端子面) Terminal Surface

腳位線色定義 The wire colors description of PIN

PIN	線色 COLOR	定義 DEFINITION
1	黑 Black	溫度開關負點 Temperature switch Negative
2	綠 Green	Hall Gnd
3	X X	Hall Gnd
4	黃 Yellow	Hall +V
5	編織網 Braid Sleeve	Gnd
6	白 White	溫度開關正點 Temperature SW.Positive
7	棕 Brown	Hall U相
8	紅 Red	Hall V相
9	橙 Orange	Hall W相
10	X X	Gnd

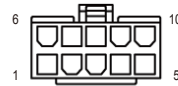

(B-B端子面) Terminal Surface



(AA動力線可接受1至5米訂製)
Customize the length of
AA power cable(1-5mm)



(BB迴授線可接受1至5米訂製)
Customize the length of
BB feedback cable(1-5mm)

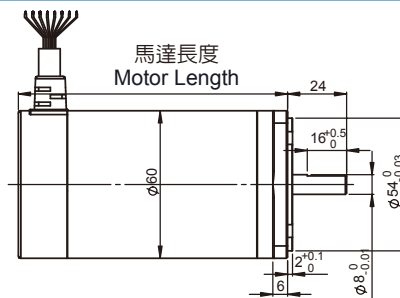
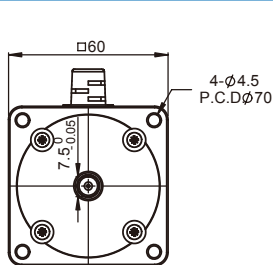

60

Type	馬達長度 Motor Length
40W	59
80W	108
120W	127

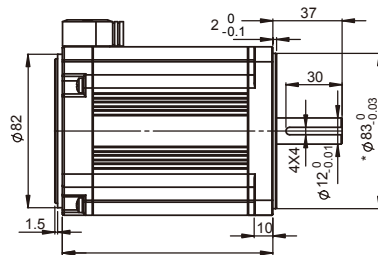
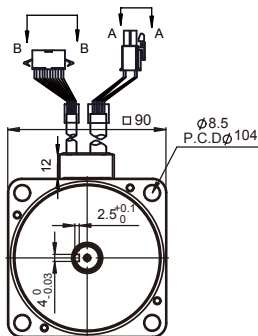

90

Type	馬達長度 Motor Length
175W	63
350W	88
500W	113

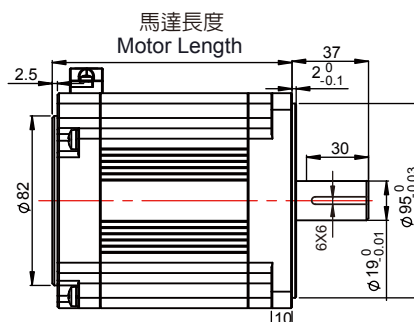
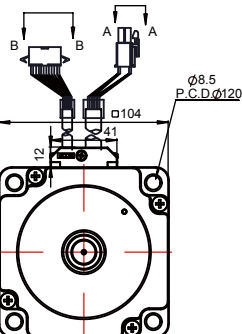

104

Type	馬達長度 Motor Length
400W	85
750W	116
1000W	145



仕彰自動化有限公司
SHIH CHANG AUTOMATION CO.LTD
E-mail: cds.servo@msa.hinet.net
Website: http://www.cds-servo.com

台灣台中市東區東福一街28號
NO.28,Dong Fu 1st ST.,East District, Taichung city 40148,Taiwan(R.O.C.)
TEL:886-4-22830909
FAX:886-4-22830707